

JIS Marine Valves

RATER

MARINE BRONZE HOSE GLOBE VALVE 10K

JIS F7334

船用青铜皮笼阀 10kgf/cm²

MATERIAL

Body	Bronze
Bonnet	Bronze or Brass
Disc	Bronze
Seat	Bronze
Stem	Brass
Handwheel	Cast iron

PICTURE



DRAWING

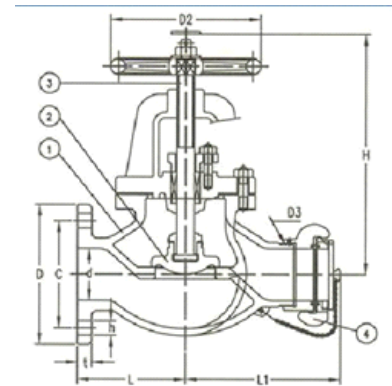

Pressure Rating	
Fluid condition	Maximum working pressure MPa(kgf/cm ²)
Steam of 205°C or less	0.98 (10)
Air, gas, oil & pulsation water	
Non-shock water of 120°C or less	1.37 (14)

Hydraulic Inspection	
Watertight inspection for valve seat	0.69MPa(7kgf/cm ²)
Hydraulic Inspection for body	1.37MPa(14kgf/cm ²)

Technical Data

Manufactured in accordance to JIS F7400 • Flanges as per JIS B2220 - 5K •
 Screwed bonnet for sizes DN 15 – DN 25 • Bolted bonnet for sizes DN 40 – DN 65

DIMENSIONS

CODE	SIZE	L	L1	D	C	No.	h	t	H	D2	D3
75 17 02	15	73	55	95	70	4	15	12	129	80	M42x2
75 17 04	25	83	65	125	90	4	19	14	161	125	M42x2
75 17 12	40	133	90	140	105	4	19	16	193	140	M52x2
75 17 17	50	165	110	155	120	4	19	16	271	160	M64x2
75 17 18	65	200	135	175	140	4	19	18	298	200	M80x2

Notice: Unit (mm)